

Szabályozó

DRU



Leírás

Forgatható, vágott szeleplappal rendelkezik. A szelelap fokozatmentesen állítható 0-90°. A szabályozó lehetővé teszi kb. 50 mm-es szigetelés alkalmazását.

A szelelapot úgy alakították ki, hogy minimális legyen a sajáztajkeltés. A sajáztaj kb. megegyezik a perforált szelelapokéval. A szelelap kevésbé érzékeny a szennyeződésekre a perforáció hiánya miatt.

Beállítási szög α

$\alpha = 0^\circ$ = nyitott szelelap, $\alpha = 90^\circ$ = zárt szelelap

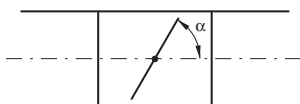

A sapka Ø80-630 méretben kiegészíthető speciális IK sapkával, ha a szigetelés 50 mm-nél vastagabb.

Megerősített szelelap

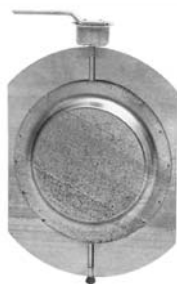

Rendelési minta

Termék **DRU** **125**

Méret Ød_1

Méretek

Ø 80–630

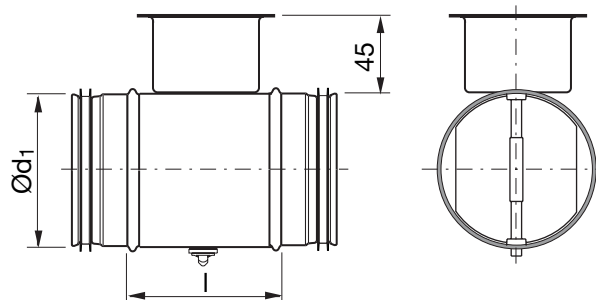

Ø 800–1000

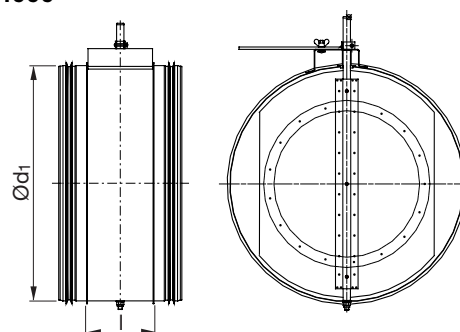

Ød ₁ névl	l mm	m kg	Tömörsegi osztály zárt szelep mögött
80	100	0,34	0
100	100	0,40	0
112	100	0,43	0
125	100	0,46	0
140	100	0,54	0
150	100	0,60	0
160	100	0,65	0
180	100	0,69	0
200	100	0,80	0
224	100	0,90	0
250	100	1,28	0
280	100	1,40	0
300	100	1,62	0
315	100	1,70	0
355	100	2,01	0
400	100	2,82	0
450	100	3,70	0
500	115	4,70	0
560	115	5,51	0
600	115	5,90	0
630	115	6,21	0
800	230	18,2	0
1000	230	24,4	0



Szabályozó

DRU

- 1
- 2
- 3
- 4
- 5
- 6
- 7
- 8
- 9
- 10
- 11
- 12
- 13
- 14
- 15
- 16
- 17
- 18

Tulajdonság	Ø 80-315	Ø 400	Ø 500	Ø 630	Ø 800x1000
A szelep tömszelencén keresztül állítható.	x	x	x	x	
A szelep beállítása a perselyen feltüntetett skála szerint olvasható	x	x	x	x	
A szelep két csavarral rögzíthető (PZD2)	x	x	x	x	
A szeleplap szárnyas anyával rögzített.					x
A szeleplap megerősített.			x	x	
A szeleplap utólag megerősítve.					x
Erős fogantyúval.		x	x	x	
Utólag megerősített fogantyúval.					x
Megerősített végperemmel.			x	x	
A tengely megerősített.					x
A szelep motorhoz előkészítve szállítható.	x	x	x	x	
A szelep motorral felszerelve szállítható	x	x	x	x	x

Műszaki adatok

Nyomáscsökkentő diagram zaj adatokkal a méretezéshez

A folytonos görbék mutatják a nyomáscsökkentést, Δp_t , a szabályozón keresztül a térfogatáram, q , és a beállítási szög α függvényében.

A szaggatott görbék megadják az A-súlyozott hangteljesítményszint, L_{WA} (dB(A)) adatokat a légcsatornában.

Példa

Adott

- Méret Ø100
- Térfogatáram 60 l/s
- Nyomáscsökkentés 200 Pa

Diagramból kiolvassa

- Beállítási szög 40°
- Hangteljesítményszint 63 dB (A)

Ø80

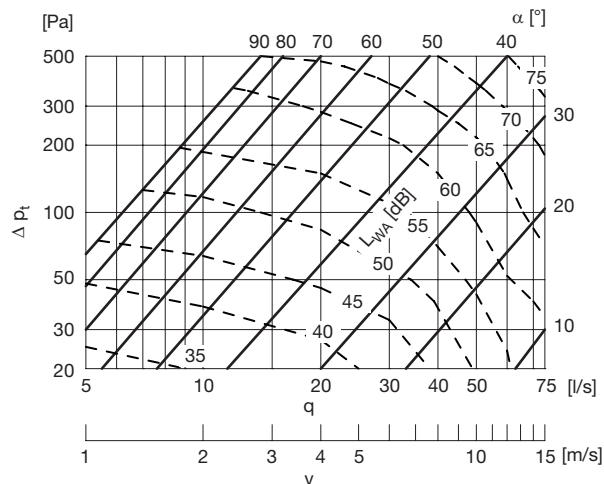

Ø100

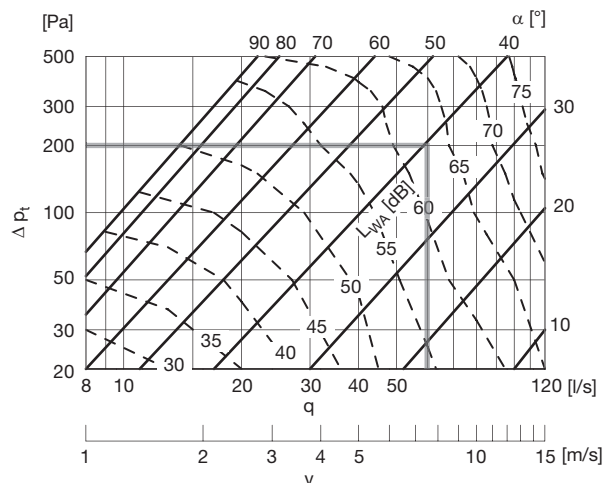

Szabályozó

DRU

Ø112

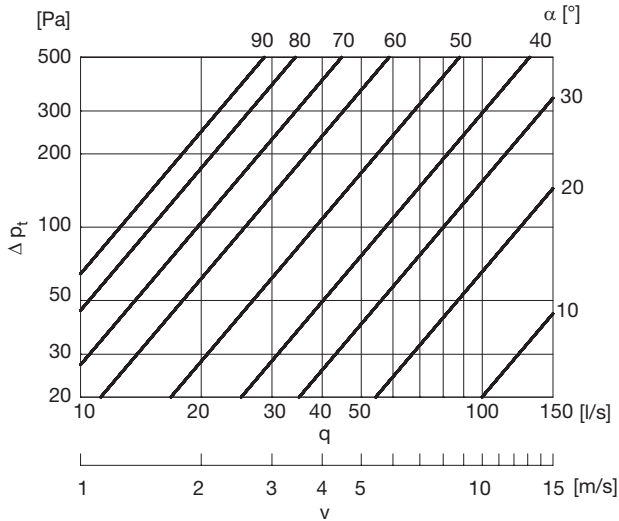

Ø150

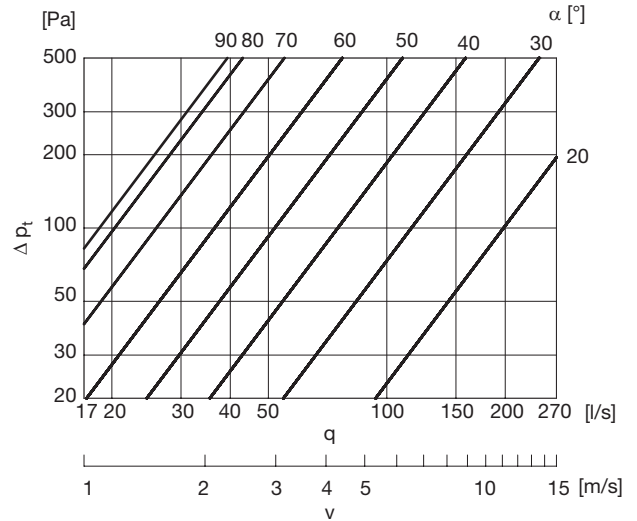

Ø125

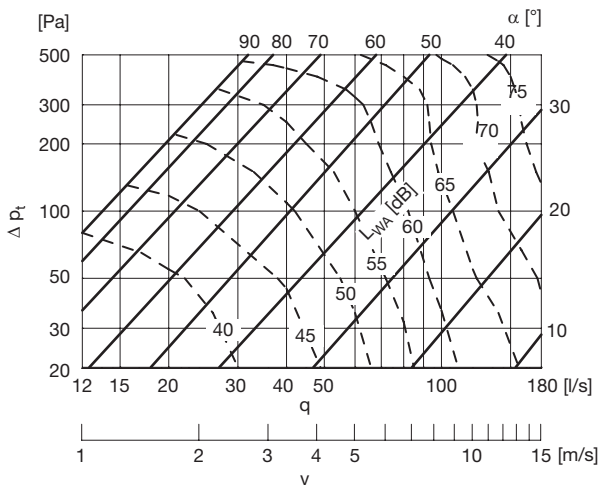

Ø160

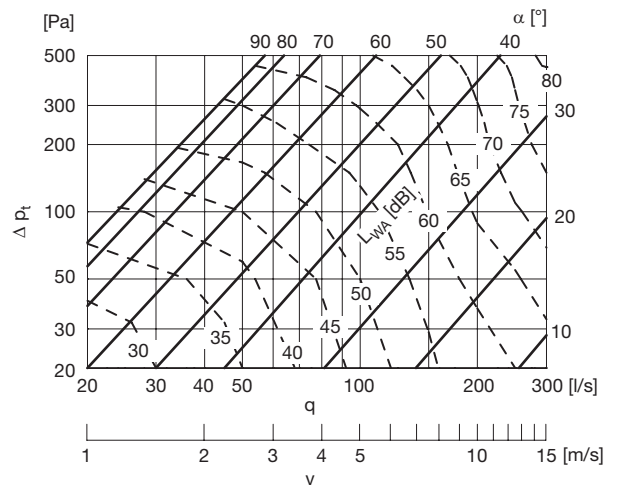

Ø140

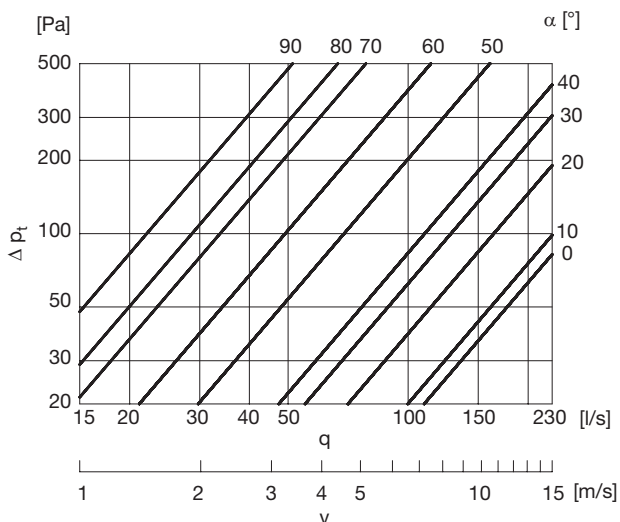

Ø180

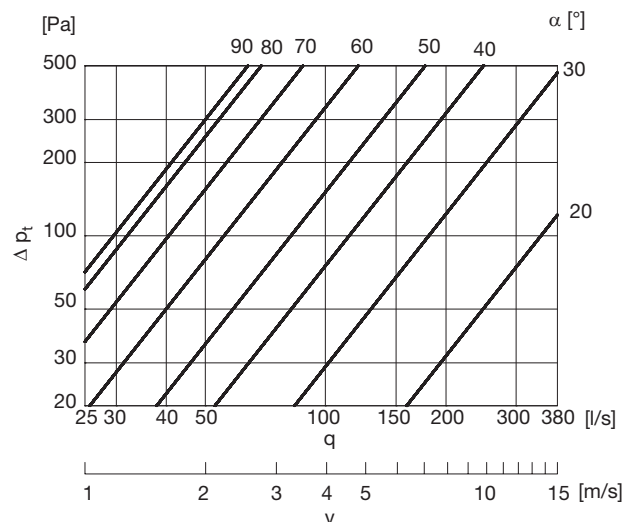

Szabályozó

DRU

- 1
- 2
- 3
- 4
- 5
- 6
- 7
- 8
- 9
- 10
- 11
- 12
- 13
- 14
- 15
- 16
- 17
- 18

Ø200

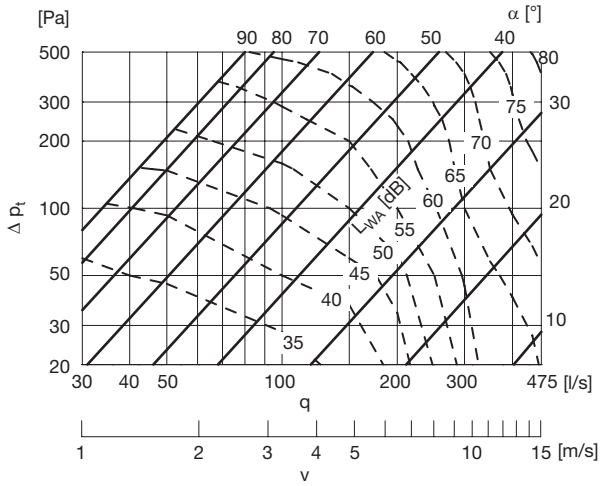

Ø280

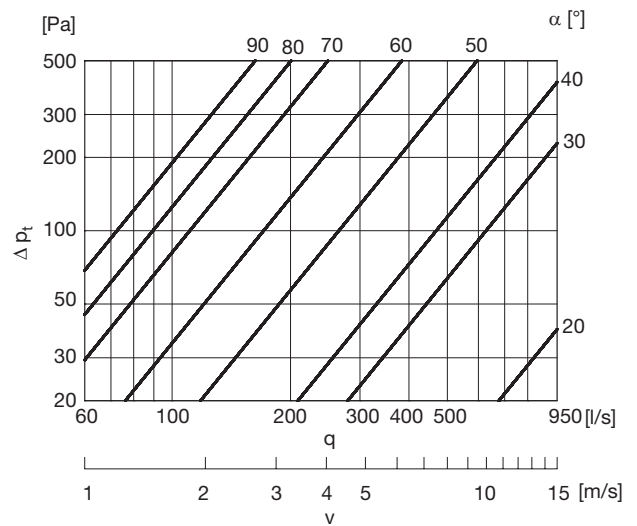

Ø224

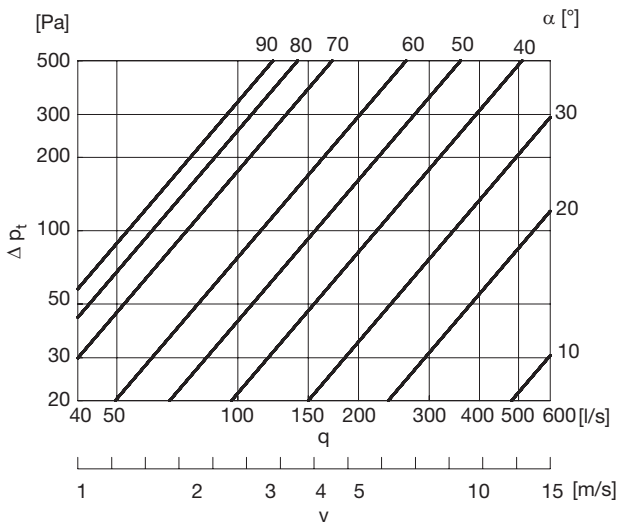

Ø300

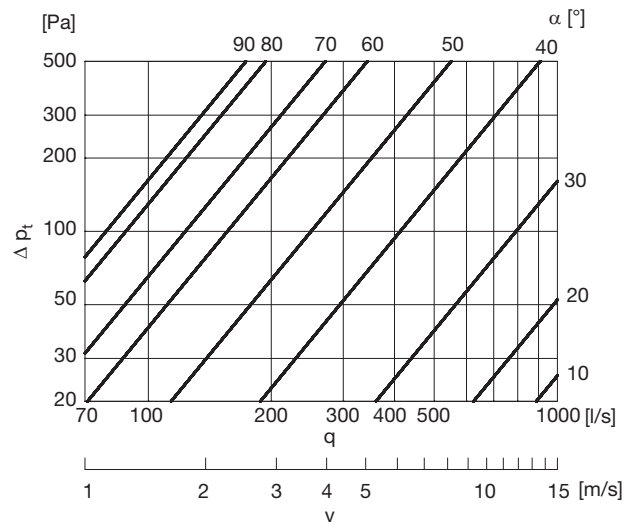

Ø250

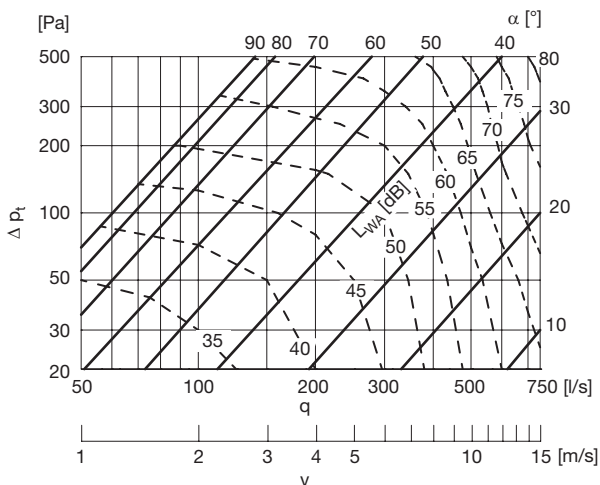

Ø315

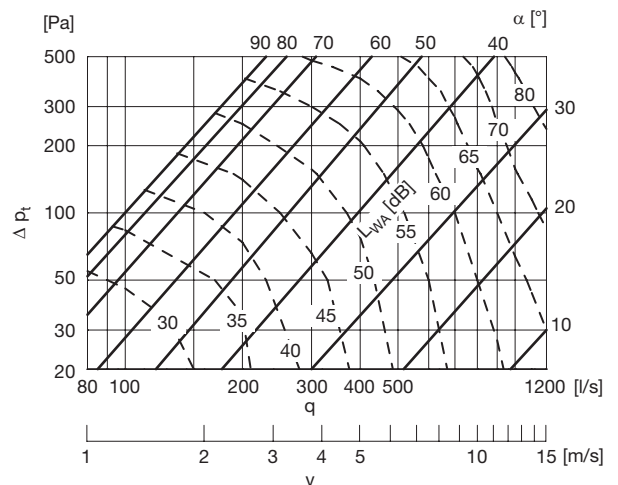

Szabályozó

DRU

Ø355

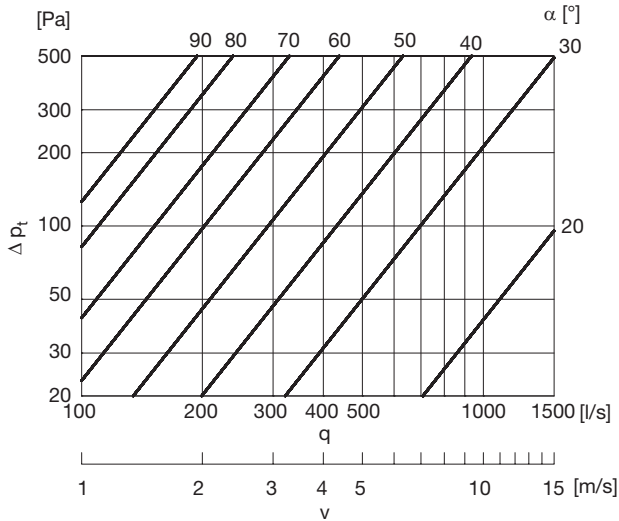

Ø400

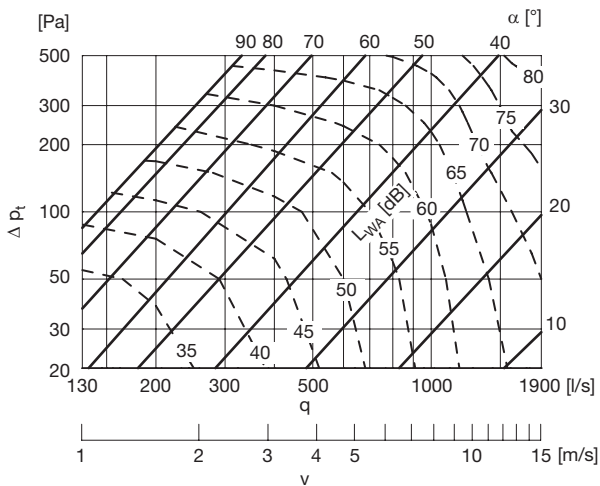

Ø450

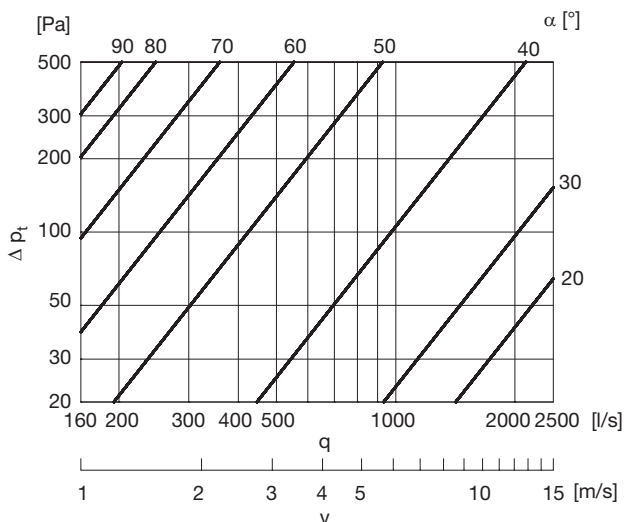

Ø500

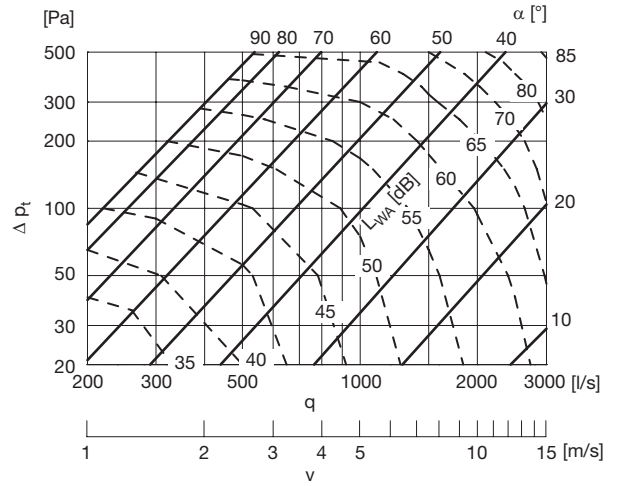

Ø560

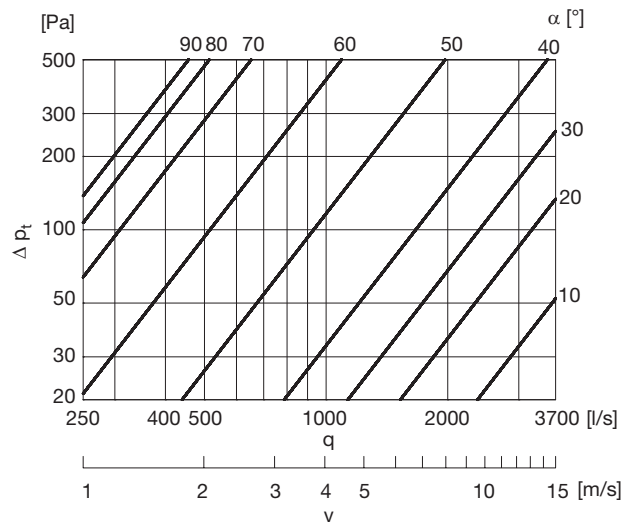

Ø600

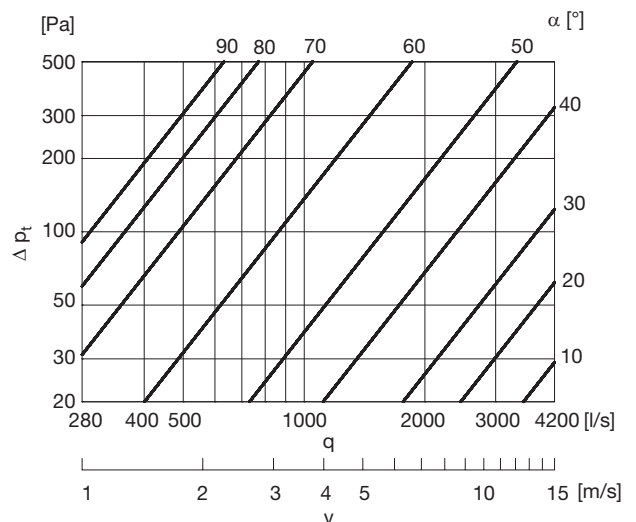

- 1
- 2
- 3
- 4
- 5
- 6
- 7
- 8
- 9
- 10
- 11
- 12
- 13
- 14
- 15
- 16
- 17
- 18

Szabályozó

DRU

- 1
- 2
- 3
- 4
- 5
- 6
- 7
- 8
- 9
- 10
- 11
- 12
- 13
- 14
- 15
- 16
- 17
- 18

Ø630

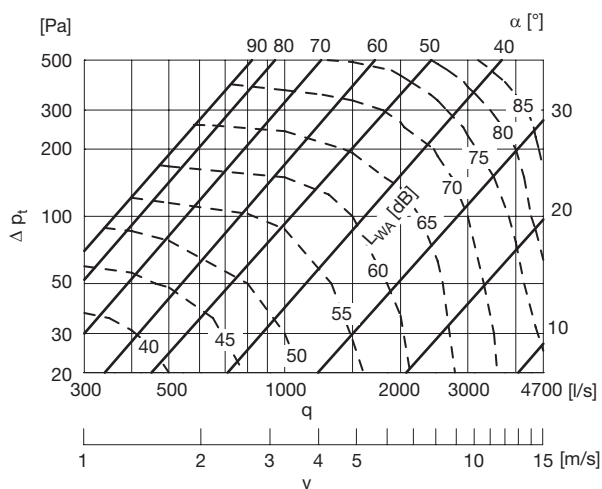

Ø900

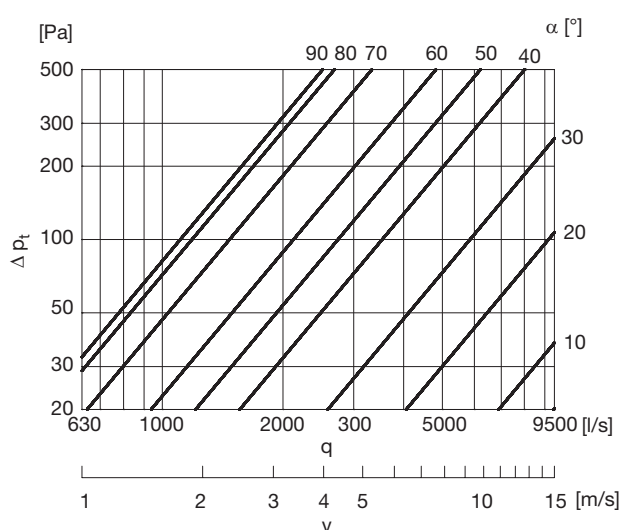

Ø710

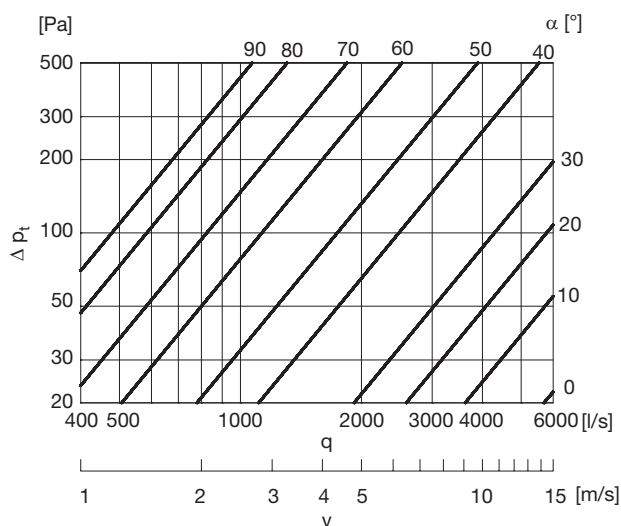

Ø1000

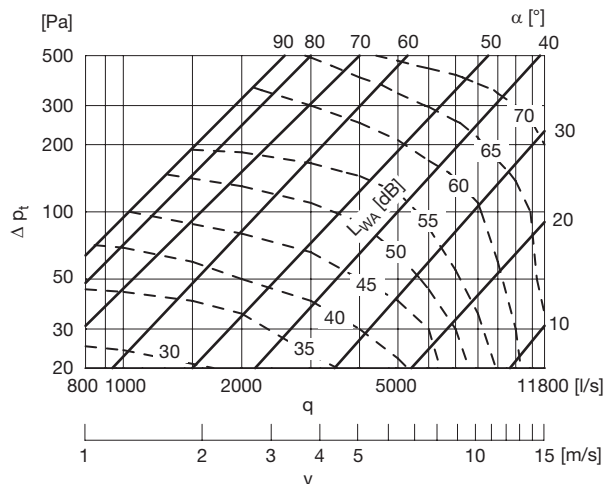

Ø800

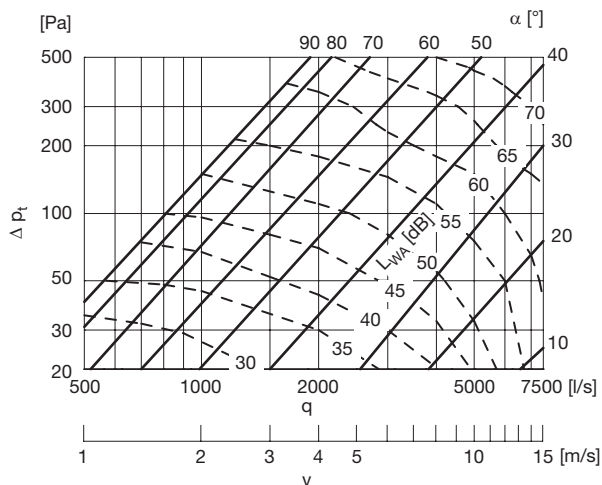

Szabályozó

DRU

DRU zaj adatai

Hangteljesítményszint L_{W} , [dB] a légcatornában oktávsávokra bontva, 63–8000 Hz, átmérő, térfogatáram és nyomásesés függvényében.

Az akusztikai adatok mérése az ISO 5135 és az ISO 3741 szabvány eljárásai szerint történtek, a Svéd Nemzeti Vizsgáló és Kutató Intézet ajánlásai szerint.

méret \varnothing_{d_1}	Nyomásesés [Pa]	Légsebesség 1 [m/s]								Légsebesség 3 [m/s]								Légsebesség 6 [m/s]							
		Középfrekvencia (Hz)								Középfrekvencia (Hz)								Középfrekvencia (Hz)							
		63	125	250	500	1k	2k	4k	8k	63	125	250	500	1k	2k	4k	8k	63	125	250	500	1k	2k	4k	8k
80		Térfogatáram 5 [l/s]								Térfogatáram 15 [l/s]								Térfogatáram 30 [l/s]							
	500	-	-	-	-	-	-	-	65	65	65	65	59	55	49	46	67	67	67	67	60	57	50	47	
	200	-	-	-	-	-	-	-	63	63	60	54	51	43	34	29	65	65	62	56	53	44	35	30	
	100	-	-	-	-	-	-	-	60	60	53	48	43	30	23	15	61	64	57	51	46	32	24	16	
	50	53	49	43	40	33	23	15	8	56	54	47	43	36	25	16	9	59	59	52	47	40	27	17	10
20	47	42	36	32	25	16	7	1	51	47	39	35	28	18	8	2	54	52	44	39	32	20	9	4	
100		Térfogatáram 8 [l/s]								Térfogatáram 25 [l/s]								Térfogatáram 50 [l/s]							
	500	-	-	-	-	-	-	-	67	64	64	57	54	48	48	48	72	69	69	62	59	52	52	52	
	200	-	-	-	-	-	-	-	59	58	58	50	48	40	37	37	66	65	64	57	54	45	42	42	
	100	-	-	-	-	-	-	-	58	55	53	46	41	34	26	24	65	64	62	54	48	40	31	29	
	50	48	42	38	33	26	19	16	14	55	53	48	42	35	26	22	18	64	63	60	53	44	33	28	22
20	43	35	30	23	17	9	7	6	50	49	42	37	28	17	15	14	62	61	57	51	41	27	25	15	
125		Térfogatáram 12 [l/s]								Térfogatáram 40 [l/s]								75 [l/s]							
	500	-	-	-	-	-	-	-	71	68	65	59	56	50	50	47	76	73	70	63	60	53	53	50	
	200	-	-	-	-	-	-	-	65	62	57	51	46	41	38	38	72	71	65	59	53	47	43	43	
	100	-	-	-	-	-	-	-	64	59	53	47	39	34	29	27	71	70	63	55	47	40	35	32	
	50	57	42	41	31	29	20	17	15	63	54	50	41	36	27	25	20	70	68	60	51	43	34	32	24
20	56	32	39	29	27	11	15	11	62	48	48	34	34	20	22	15	68	65	56	47	39	29	28	17	
160		Térfogatáram 20 [l/s]								Térfogatáram 60 [l/s]								Térfogatáram 120 [l/s]							
	500	-	-	-	-	-	-	-	68	67	64	59	55	53	52	51	73	71	68	62	59	55	54	53	
	200	-	-	-	-	-	-	-	61	58	56	50	48	42	40	40	71	65	62	56	53	47	44	44	
	100	-	-	-	-	-	-	-	59	54	50	45	40	35	33	31	70	64	60	53	48	42	39	38	
	50	42	36	33	28	25	20	17	16	54	50	46	37	33	29	25	25	69	63	58	48	42	37	32	32
20	37	30	30	26	19	16	11	10	49	46	43	35	27	24	19	18	68	61	55	44	36	32	27	23	
200		Térfogatáram 30 [l/s]								Térfogatáram 100 [l/s]								Térfogatáram 200 [l/s]							
	500	-	-	-	-	-	-	-	70	64	61	55	52	52	55	55	75	69	65	59	55	55	59	59	
	200	-	-	-	-	-	-	-	62	57	55	47	44	42	42	42	71	65	61	53	50	48	47	47	
	100	-	-	-	-	-	-	-	57	52	48	41	39	36	34	34	69	64	58	50	47	44	42	42	
	50	40	38	33	30	28	27	23	22	51	45	41	36	32	32	28	28	63	56	51	44	39	39	34	34
20	34	31	26	25	23	18	16	44	37	33	29	27	25	21	19	56	47	43	36	29	27	24	22		
250		Térfogatáram 50 [l/s]								Térfogatáram 150 [l/s]								Térfogatáram 300 [l/s]							
	500	-	-	-	-	-	-	-	69	66	59	53	50	54	53	52	71	67	61	56	53	56	55	54	
	200	-	-	-	-	-	-	-	59	57	52	46	44	41	44	44	63	60	55	49	46	44	46	46	
	100	-	-	-	-	-	-	-	56	52	45	41	38	36	34	31	62	57	51	46	43	40	38	35	
	50	44	41	35	32	29	24	22	20	52	48	40	38	34	30	28	24	61	56	47	45	40	38	33	28
20	33	35	29	29	25	12	10	47	44	37	35	31	25	22	17	59	54	46	42	38	36	30	24		
315		Térfogatáram 80 [l/s]								Térfogatáram 250 [l/s]								Térfogatáram 500 [l/s]							
	500	-	-	-	-	-	-	-	68	65	59	53	50	50	53	50	74	71	65	58	55	55	58	55	
	200	-	-	-	-	-	-	-	60	55	50	45	43	40	43	40	70	65	58	52	49	48	49	46	
	100	-	-	-	-	-	-	-	54	52	45	41	38	36	36	31	66	64	56	50	47	46	44	39	
	50	34	34	30	26	22	21	19	15	49	49	43	38	34	32	30	24	64	63	55	49	45	42	40	32
20	26	30	27	21	16	15	13	11	44	46	41	35	30	27	25	18	62	61	54	48	43	37	34	24	
400		Térfogatáram 130 [l/s]								Térfogatáram 400 [l/s]								Térfogatáram 800 [l/s]							
	500	-	-	-	-	-	-	-	79	73	67	62	57	60	59	58	82	75	68	65	59	62	61	60	
	200	-	-	-	-	-	-	-	67	62	56	50	48	48	48	45	74	68	62	56	53	52	52	49	
	100	-	-	-	-	-	-	-	61	56	49	44	42	39	39	34	72	67	58	53	49	47	46	40	
	50	42	37	31	29	28	27	25	20	57	52	44	39	37	35	34	26	71	66	56	50	47	44	44	33
20	40	34	27	25	24	23	21	11	55	50	40	35	34	32	30	20	70	65	54	47	44	40	38	28	
500		Térfogatáram 200 [l/s]								Térfogatáram 600 [l/s]								Térfogatáram 1200 [l/s]							
	500	-	-	-	-	-	-	-	84	77	70	64	63	62	61	60	85	78	71	65	64	63	62	61	
	200	-	-	-	-	-	-	-	71	65	59	53	50	50	50	47	77	70	64	58	56	55	54	51	
	100	-	-	-	-	-	-	-	63	58	53	47	46	44	42	37	72	66	60	55	53	51	49	43	
	50	46	40	36	33	32	29	29	25	59	52	47	44	42	38	38	31	71	63	57	54	51	46	46	37
20	41	33	29	27	26	19	18	20	56	47	42	40	38	32	30	26	70	60	54	52	49	44	40	32	
630		Térfogatáram 300 [l/s]								Térfogatáram 900 [l/s]								Térfogatáram 1800 [l/s]							
	500	-	-	-	-	-	-	-	88	80	73	69	66	64	63	62	90	83	75	71	68	67	65	64	
	200	-	-	-	-	-	-	-	78	72	65	62	59	55	55	49	80	74	67	64	60	57	57	50	
	100	-	-	-	-	-	-	-	71	66	59	54	50	46	45	40	78	71	66	59	56	49	48	44	
	50	54	49	45	39	34	36	30	26	66	58	53	48	43	40	39	30	77	68	62	57	51	45	47	36
20	45	35	38	30	29	29	26	20	61	50	47	43	38	36	33	25	76	65	57	55	46	42	39	30	
800		Térfogatáram 500 [l/s]								Térfogatáram 1500 [l/s]								Térfogatáram 3000 [l/s]							
	500	-	-	-	-	-	-	-	-	-	-	-	-	-	-	-	72	65	62	63	62	62	61	56	
	200	-	-	-	-	-	-	-	58	52	49	49	50	49	45	37	67	60	56	55	53	52	49	43	
	100	-	-	-	-	-	-	-	55	48	45	44	44	40	35	29	63	55	51	49	47	44	40	34	
	50	-	-	-	-	-	-	-	52	44	40	38	35	31	26	20	60	50	46	44	41	37	33	25	
20	31	33	27	22	21	11	12	1	44	36	32	28	25	17	13	2	56	40	37	34	29	23	14	9	
1000		Térfogatáram 800 [l/s]								Térfogatáram 2400 [l/s]								Térfogatáram 4750 [l/s]							
	500	-	-	-	-	-	-	-	68	62	58	58	57	57	56	53	77	70	66	67	64	64	63	57	
	200	-	-	-	-	-	-	-	64	56	53	52	52	51	48	38	72	64	58	56	54	52	50	42	
	100	-	-	-	-	-	-	-	60	52	46	45	44	41	37	28	67	58	53	49	47	44	40	32	
	50	50	40	32	34	31	26	21	10	56	47	40	39	36	31	27	15	62	54	48	44	41	37	33	25
20	47	22	27	29	19	6	2	1	50	34	33	32	25	17	7	2	53	45	39	35	32	28	22	14	



Szabályozó

DRU

- 1
- 2
- 3
- 4
- 5
- 6
- 7
- 8
- 9
- 10
- 11
- 12
- 13
- 14
- 15
- 16
- 17
- 18

méret Ød ₁	Nyomás- esés [Pa]	Légsebesség 9 [m/s]							Légsebesség 12 [m/s]							Légsebesség 15 [m/s]									
		Középfrekvencia (Hz)							Középfrekvencia (Hz)							Középfrekvencia (Hz)									
		63	125	250	500	1k	2k	4k	8k	63	125	250	500	1k	2k	4k	8k	63	125	250	500	1k	2k	4k	8k
80		Térfogatáram 45 [l/s]							Térfogatáram 60 [l/s]							Térfogatáram 75 [l/s]									
	500	72	70	70	70	63	60	53	49	77	76	75	75	68	64	56	53	80	80	80	80	72	68	60	56
	200	70	68	67	60	57	48	38	32	75	74	71	65	61	51	41	34	78	77	72	70	64	53	42	35
	100	66	65	63	57	51	36	27	18	74	73	70	60	57	45	32	25	77	75	71	65	58	46	33	26
	50	63	62	58	52	45	28	18	11	73	71	66	55	52	40	25	19	75	72	67	58	53	41	26	20
	20	59	58	51	46	38	21	10	5	70	67	60	47	44	32	17	13	72	68	62	50	47	36	20	15
100		Térfogatáram 75 [l/s]							Térfogatáram 100 [l/s]							Térfogatáram 120 [l/s]									
	500	78	75	75	67	64	57	57	57	84	81	80	72	68	62	61	61	88	86	85	76	72	65	64	64
	200	74	73	72	64	59	50	47	46	80	79	78	69	66	55	51	51	84	83	81	72	68	59	55	54
	100	73	72	71	62	56	46	36	33	79	78	75	65	60	49	44	42	82	81	78	69	63	54	48	45
	50	72	70	68	58	51	40	29	23	77	76	70	60	53	43	36	31	80	79	74	65	57	48	40	35
	20	70	67	63	53	44	33	26	17	74	73	65	54	46	37	27	20	78	77	69	60	50	41	31	24
125		Térfogatáram 110 [l/s]							Térfogatáram 145 [l/s]							Térfogatáram 180 [l/s]									
	500	83	80	76	68	65	58	54	89	87	81	73	69	62	62	58	91	88	83	75	71	63	63	59	
	200	79	78	71	65	58	51	48	47	87	85	78	70	63	56	52	48	88	86	80	71	66	59	54	49
	100	78	77	70	61	51	45	39	35	86	83	75	66	58	50	44	39	87	84	78	69	61	53	47	42
	50	77	76	68	57	45	39	33	25	84	80	71	61	52	44	36	28	86	82	75	65	55	47	39	33
	20	76	75	64	53	40	33	30	18	81	76	66	55	45	38	32	19	85	81	71	60	48	41	34	22
160		Térfogatáram 140 [l/s]							Térfogatáram 240 [l/s]							Térfogatáram 300 [l/s]									
	500	78	77	74	67	63	60	59	58	84	84	80	72	68	65	65	65	89	89	85	77	73	69	69	69
	200	76	73	70	63	59	53	50	50	80	80	77	69	66	58	55	55	85	84	80	73	70	64	59	58
	100	75	72	69	61	54	48	45	44	78	76	73	66	61	53	50	48	83	80	77	70	65	58	54	52
	50	74	71	66	58	49	40	38	33	76	72	68	62	55	47	43	38	80	76	72	66	59	51	47	42
	20	73	66	61	54	43	35	30	25	74	68	63	57	48	40	35	27	76	71	65	61	52	43	39	30
200		Térfogatáram 300 [l/s]							Térfogatáram 400 [l/s]							Térfogatáram 475 [l/s]									
	500	85	79	72	65	62	61	65	65	92	85	79	72	68	66	71	70	95	89	82	73	71	70	74	73
	200	83	77	70	62	58	55	54	54	90	83	77	69	65	62	61	60	92	85	79	71	66	64	64	63
	100	82	76	69	59	56	53	50	50	88	80	73	65	61	58	55	53	90	83	76	68	63	61	58	56
	50	81	74	65	56	52	49	45	42	85	76	68	60	56	52	48	45	88	80	72	64	59	56	52	48
	20	80	70	60	52	46	43	38	32	81	72	62	54	50	45	40	36	86	76	67	59	54	50	47	39
250		Térfogatáram 450 [l/s]							Térfogatáram 600 [l/s]							Térfogatáram 750 [l/s]									
	500	78	75	68	61	58	61	60	59	87	83	76	68	68	68	68	68	94	90	82	74	71	74	74	74
	200	74	69	63	57	55	54	54	53	82	79	72	64	63	63	62	61	88	84	77	69	68	67	68	65
	100	72	68	60	56	52	49	45	42	79	76	69	62	60	60	58	57	85	81	74	67	65	63	62	59
	50	69	67	58	54	48	44	37	32	76	72	65	59	56	54	51	48	82	78	70	64	61	58	55	52
	20	66	65	56	52	44	39	32	27	73	68	61	56	51	46	42	38	79	75	65	60	56	53	47	46
315		Térfogatáram 750 [l/s]							Térfogatáram 1000 [l/s]							Térfogatáram 1200 [l/s]									
	500	82	78	71	64	60	60	60	60	89	85	77	69	68	67	69	65	92	88	80	72	71	70	72	68
	200	77	72	66	59	58	57	56	52	86	79	72	65	63	62	63	58	88	83	75	68	66	65	64	59
	100	76	71	64	57	54	52	50	44	84	77	69	62	60	58	57	53	87	80	72	65	63	61	59	55
	50	75	70	61	54	50	46	43	35	82	74	66	59	55	52	49	46	85	77	69	62	59	55	52	48
	20	74	68	58	51	46	39	36	26	80	71	63	56	48	44	39	38	82	74	66	60	54	47	46	40
400		Térfogatáram 1200 [l/s]							Térfogatáram 1500 [l/s]							Térfogatáram 1900 [l/s]									
	500	88	81	74	70	63	66	65	64	95	87	79	75	69	71	70	69	98	90	82	78	73	74	73	72
	200	83	76	68	61	60	59	58	54	89	82	75	69	67	64	63	60	92	84	77	70	69	67	65	63
	100	82	75	67	60	58	55	53	47	86	80	72	66	63	61	58	55	89	82	74	68	66	64	61	58
	50	80	73	65	58	56	51	47	39	83	77	68	63	58	56	52	48	86	80	71	66	62	59	55	51
	20	77	70	63	55	53	47	42	30	80	74	64	60	54	50	45	40	83	78	68	64	58	51	47	42
500		Térfogatáram 1800 [l/s]							Térfogatáram 2400 [l/s]							Térfogatáram 3000 [l/s]									
	500	91	84	76	68	67	68	68	67	96	88	80	72	70	73	72	71	102	94	85	78	75	77	77	76
	200	85	78	72	65	63	61	60	57	91	84	76	70	66	66	65	61	96	89	80	72	68	68	68	67
	100	82	74	69	62	59	57	55	50	88	75	70	63	60	58	56	52	93	85	76	69	65	63	61	58
	50	79	71	66	59	55	52	48	43	85	72	67	60	56	53	49	44	90	80	72	65	62	57	53	49
	20	76	67	63	56	50	47	41	36	82	69	64	57	52	48	43	37	87	75	67	61	58	54	46	40
630		Térfogatáram 2800 [l/s]							Térfogatáram 3700 [l/s]							Térfogatáram 4900 [l/s]									
	500	96	88	80	76	72	70	68	103	95	86	82	77	77	76	73	107	98	90	85	81	81	80	76	
	200	90	83	76	71	67	63	63	56	98	90	82	78	74	70	70	62	103	95	87	82	78	76	73	66
	100	89	82	75	68	63	58	55	50	95	88	79	74	70	65	63	57	100	92	84	79	75	71	67	62
	50	87	80	72	65	58	52	48	42	92	84	75	69	65	60	56	51	97	89	80	74	70	65	60	56
	20	84	77	68	61	52	45	42	33	89	82	70	63	59	55	49	43	94	86	75	68	64	58	52	48
800		Térfogatáram 4500 [l/s]							Térfogatáram 6000 [l/s]							Térfogatáram 7500 [l/s]									
	500	78	70	66	66	65	64	63	58	83	73	69	69	68	66	65	60	84	75	71	70	69	67	66	61
	200	72	64	60	59	57	55	52	46	77	67	63	62	60	58	55	49	80	70	66	65	63	61	58	52
	100	68	59	55	53	51	48	44	37	73	63	59	57	55	52	48	42	77	67	62	60	57	55	51	45
	50	66	55	51	48	45	42	37	30	71	60	55	52	49	47	41	35	76	65	61	58	54	52	47	40
	20	61	46	43	39	35	32	25	18	69	58	53	50	47	41	37	29	74	63	59	56	52	48	43	36
1000		Térfogatáram 7100 [l/s]							Térfogatáram 9450 [l/s]							Térfogatáram 11800 [l/s]									
	500	81	74	69	69	67	65	64	58	85	77	71	70	68	67	65	60	86	79	72	71	69	68	66	61
	200	76	69	63	60	57	55	53	45	80	71	65	64	61	58	57	50								